

FICHA TÉCNICA – TECHNICAL DATA SHEET: EPOXI SIN ESTIRENO – EPOXI STYRENE FREE

VENTAJAS – BENEFITS

- Anclaje con homologación CE para varillas roscada - **Homologated anchor with ETA for threaded rod.**
- Sistema compacto y fácil de usar - **Compact and user-friendly system.**
- Limpio y sencillo: El mezclador garantiza la dosificación correcta - **Clean and easy: the mixer guarantees a correct application**
- Económico: No se desperdicia la resina. Un cartucho no utilizado puede volver a usarse en varias ocasiones - **Economic: A same cartridge can be used several times.**
- Seguro: Anclaje con buen comportamiento en material hueco y macizo. Recomendado para aplicaciones en materiales huecos y macizos de cargas medias **Safe: Anchor with good behaviour in hollow and solid materials. It is recommended for applications in hollow materials and medium loads on concrete.**
- Versátil: Permite realizar fijaciones en material hueco o macizo, pudiéndose utilizar con varillas roscadas, manguitos,
Versatility: Can be used in hollow and solid materials with threaded bar, connecting nuts,...
- Excelente resistencia mecánica (superior a las resinas PY) - **Excellent mechanical resistance (higher than PY).**
- Ausencia de ftalatos y estireno (no perjudica la salud de los usuarios ni de los manipuladores) - **Free styrene and ftalate (this product don't damage the health of installers and users).**
- Fragua incluso con humedad - **It hardens under humidity.**

APLICACIONES – APPLICATIONS.

Fijación en materiales huecos y macizos / **Fixing in hollow and solid materials**

Tubería y cables / **Pipes and cables.**

Aparatos sanitarios / **Sanitary devices.**

Perfiles metálicos / **Metallic channels.**



Foto Producto / product photo



Homologaciones/ approvals

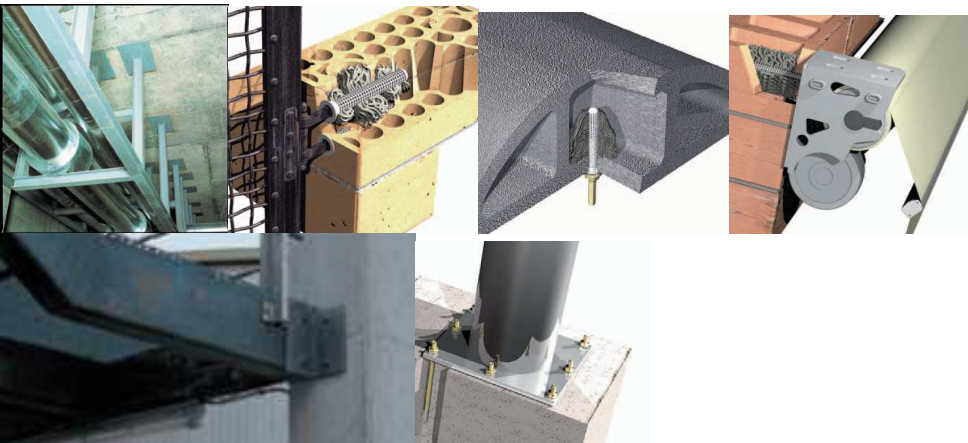

CARACTERÍSTICAS – FEATURES

9 meses de caducidad (cartuchos 300 ml), 18 meses de caducidad (cartuchos 410 ml) / *It expires in 9 months (cartridges 300ml) or 18 months (cartridges 410 ml).*



Almacenar en lugar fresco y oscuro, con temperatura entre +5°C / 25°C / *store in a cold and dark place, storage temperature: from +5°C up to +25 °C*

Materiales / *materials*

- Resina epoxi bicomponente / *2-component epoxi resin.*
- Tamices standard o con aletas / *Standard or winged sleeves.*
- Manguitos y espárragos roscados calidad 5.8, 8.8 o inoxidables / *Connecting nuts and threaded rod 5.8, 8.8 or stainless steel.*

FORMATOS DE CARTUCHO – CARTRIDGE FORMATS

Disponible en formatos 300 ml y 410 ml. / *Available in formats 300 ml and 410 ml.*

Cartucho / <i>Cartridge</i>	Pistola / <i>Gun</i>	
Cartucho 300 ml <i>Cartridge 300 ml</i>	OL 280 <i>OL 280</i>	
Cartucho 410 ml <i>Cartridge 410 ml</i>	OL 410/420 y "COX" <i>OL 410/420 and "COX"</i>	



MATERIALES BASE RECOMENDADO - SUITABLE BASE MATERIAL

Hormigón / *concrete*

Bloque hormigón / *concrete block*



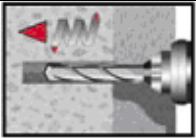
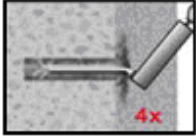



Ladrillo macizo y hueco / *solid and hollow brick*

PROCEDIMIENTO DE INSTALACIÓN EN HORMIGÓN- INSTALLATION PROCEDURE IN CONCRETE

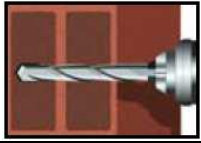
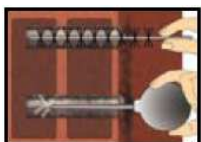
	Realizar con taladro un agujero en el material base con el diámetro y profundidad necesarios para la medida de anclaje seleccionada. <i>Drill with hammer drill a hole into the base material to the size and embedment depth required by the selected anchor.</i>
	Empezando desde el fondo, limpiar el agujero con aire comprimido o la escobilla de mano un mínimo de 4 veces. Si no se puede alcanzar el fondo se deberá utilizar un prolongador. La escobilla de mano puede ser usada para diámetros de agujero de hasta 20 mm. Para diámetros superiores a 20 mm o agujeros más profundos de 240mm se deberá utilizar aire comprimido (mínimo 6 bar). <i>Starting from the bottom or back of the bore hole, blow the hole clean with compressed air or a hand pump a minimum of four times. If the bore hole ground is not reached an extension shall be used. The hand-pump can be used for anchor sizes up to bore hole diameter 20 mm. For bore holes larger then 20mm or deeper then 240mm, compressed air (min. 6 bar) must be used.</i>
	

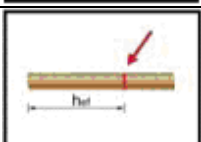
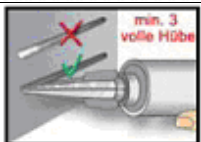
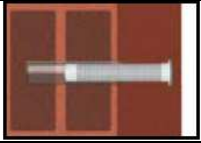
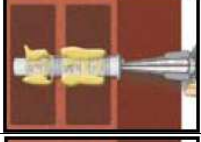
	<p>Utilizar un cepillo del diámetro necesario según la tabla 5 de la homologación CE e insertar el cepillo en un taladro o en una roscadora eléctrica. Limpiar el agujero con la longitud de cepillo > db,min un mínimo de 4 veces. Si no se puede alcanzar el fondo se deberá utilizar un prolongador.</p> <p>Check brush diameter acc. to table 5 of CE approval and attach the brush to a drilling machine or a battery screwdriver. Brush the hole with an appropriate sized wire brush > db,min a minimum of four times. If the bore hole ground is not reached with the brush, a brush extension shall be used.</p>
	<p>Finalmente limpiar de nuevo el agujero con aire comprimido o la escobilla de mano un mínimo de 4 veces. Si no se puede alcanzar el fondo se deberá utilizar un prolongador. La escobilla de mano puede ser usada para diámetros de agujero de hasta 20 mm. Para diámetros superiores a 20 mm o agujeros más profundos de 240mm se deberá utilizar aire comprimido (mínimo 6 bar).</p> <p>Finally blow the hole clean again with compressed air or a hand pump a minimum of four times. If the bore hole ground is not reached an extension shall be used. The hand-pump can be used for anchor sizes up to bore hole diameter 20 mm. For bore holes larger then 20mm or deeper then 240 mm, compressed air (min. 6 bar) must be used.</p>
	<p>Colocar el mezclador en el cartucho e insertar el cartucho en la pistola de inyección adecuada. Siempre que se interrumpa la inyección por encima del tiempo de trabajo recomendado se deberá de cambiar el mezclador.</p> <p>Attach a supplied static-mixing nozzle to the cartridge and load the cartridge into the correct dispensing tool. For every working interruption longer than the recommended working time as well as for new cartridges, a new static-mixer shall be used.</p>
	<p>Antes de insertar la varilla en el agujero lleno de resina se deberá marcar en ésta la profundidad de anclaje.</p> <p>Prior to inserting the anchor rod into the filled bore hole, the position of the embedment depth shall be marked on the anchor rods.</p>
	<p>Antes de llenar el agujero se deberá realizar la inyección a parte y descartar la resina mal mezclada hasta que ésta adquiera un color gris uniforme.</p> <p>Prior to dispensing into the anchor hole, squeeze out separately a minimum of three full strokes and discard non-uniformly mixed adhesive components until the mortar shows a consistent grey colour.</p>
	<p>Empezando por el fondo, rellenar aproximadamente dos terceras partes del agujero limpio. Separar lentamente el mezclador del fondo del agujero durante la inyección para evitar la creación de burbujas de aire. Para profundidades mayores a 190mm se deberá utilizar un prolongador. En instalaciones en horizontal con agujeros mayores a 20mm se debe utilizar un taco pistón para soportar la varilla. Véase los tiempos de fraguado de la resina.</p> <p>Starting from the bottom or back of the cleaned anchor hole fill the hole up to approximately two-thirds with adhesive. Slowly withdraw the static mixing nozzle as the hole fills to avoid creating air pockets. For embedment larger than 190mm an extension nozzle shall be used. For overhead and horizontal installation in bore holes bigger than 20mm a piston plug and extension nozzle shall be used. Observe the gel-/ working times given.</p>
	<p>Empujar la varilla roscada o corrugada dentro del agujero girándola ligeramente para garantizar una distribución homogénea. El agujero deberá estar libre de suciedad, grasa, aceite u otros materiales.</p> <p>Push the threaded rod or reinforcing bar into the anchor hole while turning slightly to ensure positive distribution of the adhesive until the embedment depth is reached. The anchor should be free of dirt, grease, oil or other foreign material.</p>
	<p>Asegurarse de que la varilla está introducida hasta el final del agujero y de que la mezcla sobresale de éste. Si no se dan estas condiciones deberá de rellenarse de nuevo el agujero e instalar una nueva varilla.</p> <p>Be sure that the anchor is fully seated at the bottom of the hole and that excess mortar is visible at the top of the hole. If these requirements are not maintained, the application has to be renewed.</p>
	<p>Dejar fraguar la mezcla correctamente respetando el tiempo de curado. No aplicar ninguna carga ni apretar el anclaje hasta que la resina no haya fraguado.</p> <p>Allow the adhesive to cure to the specified time prior to applying any load or torque. Do not move or load the anchor until it is fully cured.</p>
	<p>Tras el tiempo de curado se puede realizar la instalación con el par de apriete adecuado utilizando para ello una llave dinamométrica.</p> <p>After full curing, the add-on part can be installed with the max. torque by using a calibrated torque wrench.</p>

PROCEDIMIENTO DE INSTALACIÓN EN LADRILLO HUECO – INSTALLATION PROCEDURE IN HOLLOW BRICK

	<p>Taladrar un agujero sin precursor en el material base con la dimensión y profundidad requerida por el anclaje. Drill without hammer drill a hole into the base material to the size and embedment depth required by the selected anchor.</p>
	<p>En caso de presencia de agua en el agujero se deberá sacar de éste (por ejemplo usando aire comprimido o una bomba de soplado). Limpiar el agujero con un cepillo empezando por el fondo un mínimo de 2 veces. Finalmente limpiar de nuevo el agujero 2 veces más. In case of a water filled bore hole, the water has to be removed from the hole (e.g. by compressed air or vacuum cleaner). Starting from the bottom or back of the hole, blow the hole clean with a hand pump minimum of two times. Finally clean the hole again with a hand pump a minimum of two times.</p>
	<p>Colocar el mezclador en el cartucho e insertar el cartucho en la pistola de inyección adecuada. Siempre que se interrumpa la inyección por encima del tiempo de trabajo recomendado se deberá de cambiar el mezclador. Attach a supplied static-mixing nozzle to the cartridge and load the cartridge into the correct dispensing tool. For every working interruption longer than the recommended working time as well as for new cartridges, a new static-mixer shall be used.</p>
	<p>Antes de insertar la varilla en el agujero lleno de resina se deberá marcar en ésta la profundidad de anclaje. Prior to inserting the anchor rod into the filled bore hole, the position of the embedment depth shall be marked on the anchor rods.</p>
	<p>Antes de llenar el agujero se deberá realizar la inyección a parte y descartar la resina mal mezclada hasta que ésta adquiera un color gris uniforme. Prior to dispensing into the anchor hole, squeeze out separately a minimum of three full strokes and discard non-uniformly mixed adhesive components until the mortar shows a consistent grey colour.</p>
	<p>Introducir el tamiz perforado en el agujero asegurando su correcta inserción. Nunca cortar el tamiz! Solo utilizar tamices que tengan la profundidad correcta. Insert the perforated sleeve into the bore hole. Make sure the sleeve fits well into the hole. Never cut the sleeve! Only use sleeves that have the right length.</p>
	<p>Empezando por el fondo llenar la cánula completamente con resina. Observar el tiempo de inicio del endurecimiento. Starting from the back fill the sleeve completely with adhesive. Observe the gel-/working times.</p>
	<p>Empujar la varilla roscada o corrugada dentro del agujero girándola ligeramente para garantizar una distribución homogénea. El agujero deberá estar libre de suciedad, grasa, aceite u otros materiales. Push the threaded rod or reinforcing bar into the anchor hole while turning slightly to ensure positive distribution of the adhesive until the embedment depth is reached. The anchor should be free of dirt, grease, oil or other foreign material.</p>
	<p>Dejar fraguar la mezcla correctamente respetando el tiempo de curado. No aplicar ninguna carga ni apretar el anclaje hasta que la resina no haya fraguado. Allow the adhesive to cure to the specified time prior to applying any load or torque. Do not move or load the anchor until it is fully cured.</p>
	<p>Tras el tiempo de curado se puede realizar la instalación con el par de apriete adecuado utilizando para ello una llave dinamométrica. After full curing, the add-on part can be installed with the max. torque by using a calibrated torque wrench.</p>

PARÁMETROS DE INSTALACIÓN (HORMIGÓN) - INSTALLATION PARAMETERS (CONCRETE)

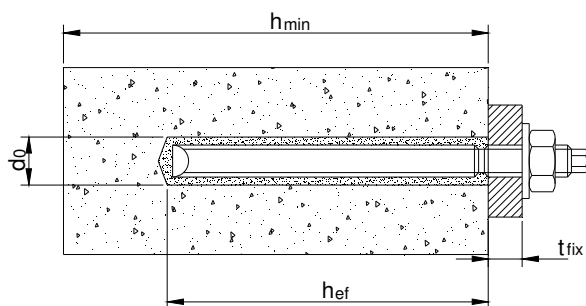

Varilla roscada / *Threaded rod*

VARILLA ROSCADA <i>THREADED ROD</i>		M8	M10	M12	M16	M20	M24
Ø broca (mm) <i>Drill hole diameter (mm)</i>	d_o	10	12	14	18	24	28
Ø taladro en pieza a fijar (mm) <i>Diameter of clearance hole in the fixture (mm)</i>	d_f	9	12	14	18	24	28
Prof. efectiva (mm) <i>Effective anchorage depth (mm)</i>	h_{ef}	80	90	110	125	170	210
Espesor mínimo hormigón (mm) <i>Minimum thickness of concrete (mm)</i>	h_{min}	110	120	140	160	210	260
Par de apriete (Nm) <i>Required torque (Nm)</i>	T_{inst}	10	20	40	60	120	150
Distancia característica entre anclajes (mm) <i>Characteristic space distance (mm)</i>	$S_{cr,N}$	160	180	220	250	340	420
Distancia mínima entre anclajes (mm) <i>Minimum space distance (mm)</i>	S_{min}	40	50	60	80	100	120
Distancia característica al borde (mm) <i>Characteristic edge distance (mm)</i>	$C_{cr,N}$	80	90	110	125	170	210
Distancia mínima al borde (mm) <i>Minimum edge distance (mm)</i>	C_{min}	40	50	60	80	100	120

CARGA RECOMENDADA EN HORMIGÓN SECO NO FISURADO C20/25 – RECOMMENDED LOADS IN DRY UNCRACKED CONCRETE C20/25

Carga recomendada en acero 5.8 / <i>Recommended load in steel 5.8</i>						
VARILLA ROSCADA – <i>THREADED ROD</i>	M8	M10	M12	M16	M20	M24
Carga de tracción en hormigón 24°C/40°C (Kg) <i>Tension load in concrete 24°C/40°C (Kg)</i>	610	850	1320	1990	3390	5030
Carga de tracción en hormigón 50°C/80°C (Kg) <i>Tension load in concrete 50°C/80°C (Kg)</i>	470	640	990	1500	2540	3770
Carga de cortadura (Kg)* / <i>Shear load (Kg)*</i>	510	860	1200	2290	3540	5090

*Datos considerados sin separación entre la fijación y la superficie (sin brazo de palanca) / *Values without space between the fixing and the surface (without lever arm)*

Notas / *notes:*

- Factor de seguridad total incluido / *Safety factor included*
- Valores válidos para h_{ef} (mm) / *Valid values for h_{ef} (mm)*
- Carga de Diseño = 1,4 * Carga Recomendada. La Carga Recomendada ya incluye la mayoración de la carga real / *Design load = 1,4 * recommended load. The recommended load includes the increment of the load.*

FACTOR DE INCREMENTO SEGÚN HORMIGÓN – INCREASING FACTOR DEPENDING ON THE CONCRETE

La carga se debe multiplicar por el factor de corrección en función del tipo de hormigón. / *The load must be multiplied by the increasing factor depending on the concrete type.*

TIPO DE HORMIGÓN - <i>CONCRETE TYPE</i>	Hormigón C30/37 <i>Concrete C30/37</i>	Hormigón C40/50 <i>Concrete C40/50</i>	Hormigón C50/60 <i>Concrete C50/60</i>
Factor de incremento - <i>Increasing factor</i>	1,12	1,22	1,29

TIEMPO DE SECADO MÍNIMO – MINIMUM CURING TIME

Temperatura del hormigón <i>Concrete temperature</i>	Inicio endurecimiento <i>Gelling-/working time</i>	Fraguado final / <i>Full curing time</i>
-5 °C	90 min.	6 h.
0 °C	45 min.	3 h.
5 °C	25 min.	2 h.
10 °C	20 min.	100 min.
20 °C	6 min.	45 min.
30 °C	4 min.	25 min.
35 °C	2 min.	20 min.

Temperatura mínima del cartucho, 5°C, óptima 20°C / *cartridge temperature min. +5°C; optimal +20°C*

Temperatura material base un vez curada la resina entre -40°C y 80°C / *-40°C to +80°C base material temperature after full curing*

PARÁMETROS DE INSTALACIÓN (ALBAÑILERÍA) - *INSTALLATION PARAMETERS (MASONRY)*

Instalación sin Tamiz – Without sleeve installation					
Ladrillo sólido – Solid Brick		M8	M10	M12	M16
Ø broca (mm) Drill hole diameter (mm)	d_0	10	12	14	18
Ø taladro en pieza a fijar (mm) Diameter of clearance hole in the fixture (mm)	d_f	9	12	14	18
Prof. efectiva (mm) Effective anchorage depth (mm)	h_{ef}	80	90	100	100

Instalación con Tamiz – With sleeve installation						
Ladrillo hueco y Ladrillo sólido Hollow and Solid Brick		M8	M8	M10	M12	M16
Tamiz Perforado Perforated Sleeve		12x80	16x85 16x130 16x200	16x85 16x130 16x200	20x85 20x130 20x200	20x85 20x130 20x200
Ø broca (mm) Drill hole diameter (mm)	d_0	12	16	16	20	20
Ø taladro en pieza a fijar (mm) Diameter of clearance hole in fixture (mm)	d_f	9	9	12	14	18
Profundidad efectiva (mm) Effective anchorage depth (mm)	h_{ef}	80	85 130 200	85 130 200	85 130 200	85 130 200
Profundidad de agujero (mm) Bore hole depth (mm)	h_o	85	90 135 205	90 135 205	90 135 205	90 135 205

DISTANCIA ENTRE ANCLAJES Y AL BORDE – *SPACING AND EDGE DISTANCES*

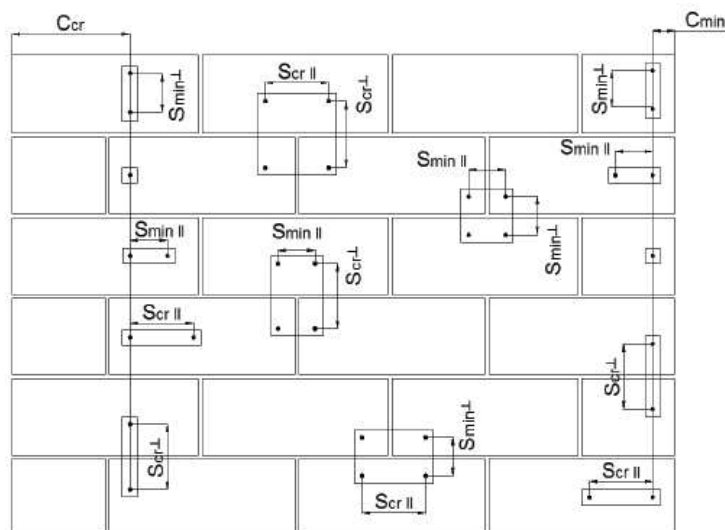

S – Spacing
C – Edge distance

CARGAS RECOMENDADAS EN ALBAÑILERÍA – RECOMMENDED LOADS IN MASONRY

Solid Calcium Silica Brick KS-NF		Dimensions 240x115x71	Compressive Strength ≥ 10 N/mm²	Density ≥ 2 kg/dm³			
Sin Tamiz – Without sleeve			M8	M10	M12	M16	
Profundidad efectiva (mm) Effective anchorage depth (mm)	h_{ef}	80	90	100	100		
Espesor mínimo pared (mm) Minimum wall thickness (mm)	h_{min}	115	240	240	240		
Par de apriete (N·m) Installation torque (N·m)	T_{inst}	2					
Distancia crítica al borde (mm) Critical edge distance (mm)	C_{cr}	120	135	150	150		
Distancia mínima a borde (mm) Minimal Edge distance (mm)	C_{min}	C_{cr}					
Distancia mínima entre anclajes paralelos a posición horiz (mm) Minimum spacing placed parallel to horizontal joint (mm)	$S_{cr,II}$	240	270	300	300		
Distancia mínima entre anclajes perpendiculares a posición horiz (mm) Minimum spacing placed perpendicular to horizontal joint (mm)	$S_{cr,T}$	240	270	300	300		
Distancia mínima entre anclajes (mm) Minimal Axial distance (mm)	S_{min}	S_{cr}					
Carga de tracción recomendada (kg) Recommended Tension Load (kg)	N_{Rec}	86					
Carga cizalladura recomendada (kg) Recommended Shear Load (kg)	V_{Rec}	86					

Con Tamiz – With sleeve		M8	M8	M10	M12	M16
Tamiz perforado - Perforated Sleeve		12	16	16	20	20
Profundidad efectiva (mm) Effective anchorage depth (mm)	h_{ef}	80	85 ; 130 ; 200			
Espesor mínimo pared (mm) Minimum wall thickness (mm)	h_{min}	115	$h_{ef} + 30$ mm			
Par de apriete (N·m) Installation torque (N·m)	T_{inst}	2				
Distancia crítica al borde (mm) Critical edge distance (mm)	C_{cr}	120	127,5			
Distancia mínima a borde (mm) Minimal Edge distance (mm)	C_{min}	C_{cr}				
Distancia mínima entre anclajes paralelos a posición horiz (mm) Minimum spacing placed parallel to horizontal joint (mm)	$S_{cr,II}$	240	255			
Distancia mínima entre anclajes perpendiculares a posición horiz (mm) Minimum spacing placed perpendicular to horizontal joint (mm)	$S_{cr,T}$	240	255			
Distancia mínima entre anclajes (mm) Minimal Axial distance (mm)	S_{min}	S_{cr}				
Carga de tracción recomendada (kg) Recommended Tension Load (kg)	N_{Rec}	71	86			
Carga cizalladura recomendada (kg) Recommended Shear Load (kg)	V_{Rec}	71	86			

Solid Clay Brick Mz-1DF		Dimensions 240x115x55	Compressive Strength ≥ 10 N/mm²	Density ≥ 1,6 kg/dm³		
Sin Tamiz – Without sleeve			M8	M10	M12	M16
Profundidad efectiva (mm) Effective anchorage depth (mm)	h_{ef}	80	90	100	100	
Espesor mínimo pared (mm) Minimum wall thickness (mm)	h_{min}	115	240	240	240	
Par de apriete (N·m) Installation torque (N·m)	T_{inst}	2				
Distancia crítica al borde (mm) Critical edge distance (mm)	C_{cr}	120	135	150	150	
Distancia mínima a borde (mm) Minimal Edge distance (mm)	C_{min}	C_{cr}				
Distancia mínima entre anclajes paralelos a posición horiz (mm) Minimum spacing placed parallel to horizontal joint (mm)	$S_{cr,II}$	240	270	300	300	
Distancia mínima entre anclajes perpendiculares a posición horiz (mm) Minimum spacing placed perpendicular to horizontal joint (mm)	$S_{cr,T}$	240	270	300	300	
Distancia mínima entre anclajes (mm) Minimal Axial distance (mm)	S_{min}	S_{cr}				
Carga de tracción recomendada (kg) Recommended Tension Load (kg)	N_{Rec}	43				
Carga cizalladura recomendada (kg) Recommended Shear Load (kg)	V_{Rec}	86	100	143	143	

Con Tamiz – With sleeve		M8	M8	M10	M12	M16
Tamiz perforado - Perforated Sleeve		12	16	16	20	20
Profundidad efectiva (mm) Effective anchorage depth (mm)	h_{ef}	80	85 ; 130 ; 200			
Espesor mínimo pared (mm) Minimum wall thickness (mm)	h_{min}	115	$h_{ef} + 30$ mm			
Par de apriete (N·m) Installation torque (N·m)	T_{inst}	2				
Distancia crítica al borde (mm) Critical edge distance (mm)	C_{cr}	120	127,5			
Distancia mínima a borde (mm) Minimal Edge distance (mm)	C_{min}	C_{cr}				
Distancia mínima entre anclajes paralelos a posición horiz (mm) Minimum spacing placed parallel to horizontal joint (mm)	$S_{cr,II}$	240	255			
Distancia mínima entre anclajes perpendiculares a posición horiz (mm) Minimum spacing placed perpendicular to horizontal joint (mm)	$S_{cr,T}$	240	255			
Distancia mínima entre anclajes (mm) Minimal Axial distance (mm)	S_{min}	S_{cr}				
Carga de tracción recomendada (kg) Recommended Tension Load (kg)	N_{Rec}	57				
Carga cizalladura recomendada (kg) Recommended Shear Load (kg)	V_{Rec}	86	86	100	100	100

Solid Light Weight Concrete-Brick LAC		Dimensions 300x123x248	Compressive Strength ≥ 2 N/mm²			Density ≥ 0,6 kg/dm³
Sin Tamiz – Without sleeve			M8	M10	M12	M16
Profundidad efectiva (mm) - Effective anchorage depth (mm)	h_{ef}	80	90	100	100	
Espesor mínimo pared (mm) Minimum wall thickness (mm)	h_{min}	300				
Par de apriete (N·m) Installation torque (N·m)	T_{inst}	2				
Distancia crítica al borde (mm) Critical edge distance (mm)	C_{cr}	120	135	150	150	
Distancia mínima a borde (mm) Minimal Edge distance (mm)	C_{min}	C_{cr}				
Distancia mínima entre anclajes paralelos a posición horiz (mm) Minimum spacing placed parallel to horizontal joint (mm)	$S_{cr,II}$	240	270	300	300	
Distancia mínima entre anclajes perpendiculares a posición horiz (mm) Minimum spacing placed perpendicular to horizontal joint (mm)	$S_{cr,T}$	240	270	300	300	
Distancia mínima entre anclajes (mm) Minimal Axial distance (mm)	S_{min}	S_{cr}				
Carga de tracción recomendada (kg) Recommended Tension Load (kg)	N_{Rec}	86	86	100	86	
Carga Vertical de cizalladura recomendada (kg) Recommended Vertical Shear Load (kg)	$V_{Rec,V}$	86	100	114	114	
Carga Horizontal de cizalladura recomendada (kg) Recommended Horizontal Shear Load (kg)	$V_{Rec,H}$	60	78	98	107	

Solid Light Weight Concrete Brick Leca Lex-Harkko RUH-200 kulma		Dimensions 498x200x195	Compressive Strength $\geq 3N/mm^2$				Density $\geq 0,78 kg/dm^3$
Sin Tamiz – Without sleeve			M8	M10	M12	M16	
Profundidad efectiva (mm) - Effective anchorage depth (mm)	h_{ef}	80	90	100	100		
Espesor mínimo pared (mm) Minimum wall thickness (mm)	h_{min}	300					
Par de apriete (N·m) Installation torque (N·m)	T_{inst}	2					
Distancia crítica al borde (mm) Critical edge distance (mm)	C_{cr}	120	135	150	150		
Distancia mínima a borde (mm) Minimal Edge distance (mm)	C_{min}	C_{cr}					
Distancia mínima entre anclajes paralelos a posición horiz (mm) Minimum spacing placed parallel to horizontal joint (mm)	$S_{cr,II}$	240	270	300	300		
Distancia mínima entre anclajes perpendiculares a posición horiz (mm) Minimum spacing placed perpendicular to horizontal joint (mm)	$S_{cr,T}$	240	270	300	300		
Distancia mínima entre anclajes (mm) Minimal Axial distance (mm)	S_{min}	S_{cr}					
Carga de tracción recomendada (kg) Recommended Tension Load (kg)	N_{Rec}	57	86				
Carga Vertical de cizalladura recomendada (kg) Recommended Vertical Shear Load (kg)	$V_{Rec,V}$	86	114				
Carga Horizontal de cizalladura recomendada (kg) Recommended Horizontal Shear Load (kg)	$V_{Rec,H}$	73	95	114	114		

Hollow Concrete Brick Leca Lex-Harkko RUH-200		Dimensions 498x200x195	Compressive Strength ≥ 2,7 N/mm²					Density ≥ 0,7 kg/dm³
			M8	M8	M10	M12	M16	
Con Tamiz – With sleeve			12	16	16	20	20	
Profundidad efectiva (mm) Effective anchorage depth(mm)	h_{ef}	80	85 ; 130					
Espesor mínimo pared (mm) Minimum wall thickness (mm)	h_{min}	200						
Par de apriete (N·m) Installation torque (N·m)	T_{inst}	2						
Distancia crítica al borde (mm) Critical edge distance (mm)	C_{cr}	100	100	100	120	120		
Distancia mínima a borde (mm) Minimal Edge distance (mm)	C_{min}	C_{cr}						
Distancia mínima entre anclajes paralelos a posición horiz (mm) Minimum spacing placed parallel to horizontal joint (mm)	$S_{cr,II}$	498						
Distancia mínima entre anclajes perpendiculares a posición horiz (mm) Minimum spacing placed perpendicular to horizontal joint (mm)	$S_{cr,T}$	195						
Distancia mínima entre anclajes(mm) Minimal Axial distance (mm)	S_{min}	S_{cr}						
Carga de tracción recomendada (kg) Recommended Tension Load (kg)	N_{Rec}	57	57	57	71	71		
Carga Vertical de cizalladura recomendada (kg) Recommended Vertical Shear Load (kg)	$V_{Rec,V}$	71	100					
Carga Horizontal de cizalladura recomendada (kg) Recommended Horizontal Shear Load (kg)	$V_{Rec,H}$	26						

Hollow Concrete Brick Bloc Creux B40		Dimensions 499x200x190	Compressive Strength ≥ 4 N/mm²					Density ≥ 0,8 kg/dm³
			M8	M8	M10	M12	M16	
Con Tamiz – With sleeve			12	16	16	20	20	
Profundidad efectiva (mm) Effective anchorage depth(mm)	h_{ef}	80	85 ; 130					
Espesor mínimo pared (mm) Minimum wall thickness (mm)	h_{min}	200						
Par de apriete (N·m) Installation torque (N·m)	T_{inst}	2						
Distancia crítica al borde (mm) Critical edge distance (mm)	C_{cr}	100	100	100	120	120		
Distancia mínima a borde (mm) Minimal Edge distance (mm)	C_{min}	C_{cr}						
Distancia mínima entre anclajes paralelos a posición horiz (mm) Minimum spacing placed parallel to horizontal joint (mm)	$S_{cr,II}$	495						
Distancia mínima entre anclajes perpendiculares a posición horiz (mm) Minimum spacing placed perpendicular to horizontal joint (mm)	$S_{cr,T}$	190						
Distancia mínima entre anclajes(mm) Minimal Axial distance (mm)	S_{min}	S_{cr}						
Carga de tracción recomendada (kg) Recommended Tension Load (kg)	N_{Rec}	11	17	17	26	26		
Carga Vertical de cizalladura recomendada (kg) Recommended Vertical Shear Load (kg)	$V_{Rec,V}$	35	86					
Carga Horizontal de cizalladura recomendada (kg) Recommended Horizontal Shear Load (kg)	$V_{Rec,H}$	26						

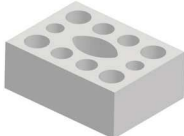
Hollow Silica Brick KS-L-3DF		Dimensions 240x175x113	Compressive Strength ≥ 12 N/mm²					Density ≥ 1,4 kg/dm³
			M8	M8	M10	M12	M16	
Con Tamiz – With sleeve			12	16	16	20	20	
Profundidad efectiva (mm) Effective anchorage depth(mm)	h_{ef}	80	85 ; 130					
Espesor mínimo pared (mm) Minimum wall thickness (mm)	h_{min}	175						
Par de apriete (N·m) Installation torque (N·m)	T_{inst}	2						
Distancia crítica al borde (mm) Critical edge distance (mm)	C_{cr}	120						
Distancia mínima a borde (mm) Minimal Edge distance (mm)	C_{min}	C_{cr}						
Distancia mínima entre anclajes paralelos a posición horíz (mm) Minimum spacing placed parallel to horizontal joint (mm)	$S_{cr,II}$	240						
Distancia mínima entre anclajes perpendiculares a posición horíz (mm) Minimum spacing placed perpendicular to horizontal joint (mm)	$S_{cr,T}$	120						
Distancia mínima entre anclajes(mm) Minimal Axial distance (mm)	S_{min}	S_{cr}						
Carga de tracción recomendada (kg) Recommended Tension Load (kg)	N_{zul}	57	57	57	171	171		
Carga Vertical de cizalladura recomendada (kg) Recommended Vertical Shear Load (kg)	$V_{Rec,V}$	57	71	71	86	86		
Carga Horizontal de cizalladura recomendada (kg) Recommended Horizontal Shear Load (kg)	$V_{Rec,H}$	26	43					

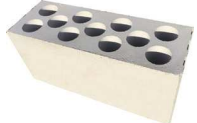
Hollow Silica Brick KS-L 12DF		Dimensions 498x175x238	Compressive Strength ≥ 12 N/mm²					Density ≥ 1,4 kg/dm³
			M8	M8	M10	M12	M16	
Con Tamiz – With sleeve			12	16	16	20	20	
Profundidad efectiva (mm) Effective anchorage depth(mm)	h_{ef}	80	85 ; 130					
Espesor mínimo pared (mm) Minimum wall thickness (mm)	h_{min}	175						
Par de apriete (N·m) Installation torque (N·m)	T_{inst}	2						
Distancia crítica al borde (mm) Critical edge distance (mm)	C_{cr}	120						
Distancia mínima a borde (mm) Minimal Edge distance (mm)	C_{min}	C_{cr}						
Distancia mínima entre anclajes paralelos a posición horíz (mm) Minimum spacing placed parallel to horizontal joint (mm)	$S_{cr,II}$	500						
Distancia mínima entre anclajes perpendiculares a posición horíz (mm) Minimum spacing placed perpendicular to horizontal joint (mm)	$S_{cr,T}$	240						
Distancia mínima entre anclajes(mm) Minimal Axial distance (mm)	S_{min}	S_{cr}						
Carga de tracción recomendada (kg) Recommended Tension Load (kg)	N_{Rec}	11	34					
Carga Vertical de cizalladura recomendada (kg) Recommended Vertical Shear Load (kg)	$V_{Rec,V}$	86	171					
Carga Horizontal de cizalladura recomendada (kg) Recommended Horizontal Shear Load (kg)	$V_{Rec,H}$	36						

Autocalved Aerated Concrete AAC		Dimensions 499x249x240	Compressive Strength $\geq 2 \text{ N/mm}^2$				Density $\geq 0,2 \text{ kg/dm}^3$
Sin Tamiz – Without sleeve			M8	M10	M12	M16	
Profundidad efectiva (mm) Effective anchorage depth (mm)	h_{ef}	80	90	100	100		
Espesor mínimo pared (mm) Minimum wall thickness (mm)	h_{min}	240					
Par de apriete (N·m) Installation torque (N·m)	T_{inst}	2					
Distancia crítica al borde (mm) Critical edge distance (mm)	C_{cr}	120	135	150	150		
Distancia mínima a borde (mm) Minimal Edge distance (mm)	C_{min}	75					
Distancia mínima entre anclajes paralelos a posición horiz (mm) Minimum spacing placed parallel to horizontal joint (mm)	$S_{cr,II}$	240	270	300	300		
Distancia mínima entre anclajes perpendiculares a posición horiz (mm) Minimum spacing placed perpendicular to horizontal joint (mm)	$S_{cr,T}$	240	270	300	300		
Distancia mínima entre anclajes (mm) Minimal Axial distance (mm)	S_{min}	100					
Carga de tracción recomendada (kg) Recommended Tension Load (kg)	N_{Rec}	89	143	179	232		
Carga Vertical de cizalladura recomendada (kg) Recommended Vertical Shear Load (kg)	V_V	241	303	357	357		
Carga Horizontal de cizalladura recomendada (kg) Recommended Horizontal Shear Load (kg)	V_H	129	168	213	232		

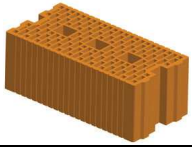
Hollow Clay Brick HLZ-16DF		Dimensions 497x240x238	Compressive Strength $\geq 8 \text{ N/mm}^2$					Density $\geq 0,8 \text{ kg/dm}^3$
			M8	M8	M10	M12	M16	
Con Tamiz – With sleeve			12	16	16	20	20	
Profundidad efectiva (mm) Effective anchorage depth(mm)	h_{ef}	80	85 ; 130 ;200					
Espesor mínimo pared (mm) Minimum wall thickness (mm)	h_{min}	240						
Par de apriete (N·m) Installation torque (N·m)	T_{inst}	2						
Distancia crítica al borde (mm) Critical edge distance (mm)	C_{cr}	120						
Distancia mínima a borde (mm) Minimal Edge distance (mm)	C_{min}	C_{cr}						
Distancia mínima entre anclajes paralelos a posición horiz (mm) Minimum spacing placed parallel to horizontal joint (mm)	$S_{cr,II}$	500						
Distancia mínima entre anclajes perpendiculares a posición horiz (mm) Minimum spacing placed perpendicular to horizontal joint (mm)	$S_{cr,T}$	240						
Distancia mínima entre anclajes(mm) Minimal Axial distance (mm)	S_{min}	S_{cr}						
Carga de tracción recomendada (kg) Recommended Tension Load (kg)	N_{Rec}	34	43	43	57	57		
Carga Vertical de cizalladura recomendada (kg) Recommended Vertical Shear Load (kg)	$V_{Rec,V}$	71	114					
Carga Horizontal de cizalladura recomendada (kg) Recommended Horizontal Shear Load (kg)	$V_{Rec,H}$	36						

Hollow Clay Brick BGV THERMO		Dimensions 500x200x314	Compressive Strength ≥ 6 N/mm²			Density ≥ 0,6 kg/dm³	
			M8	M8	M10	M12	M16
Con Tamiz – With sleeve			12	16	16	20	20
Profundidad efectiva (mm) Effective anchorage depth(mm)	h_{ef}	80	85 ; 130				
Espesor mínimo pared (mm) Minimum wall thickness (mm)	h_{min}	200					
Par de apriete (N·m) Installation torque (N·m)	T_{inst}	2					
Distancia crítica al borde (mm) Critical edge distance (mm)	C_{cr}	120					
Distancia mínima a borde (mm) Minimal Edge distance (mm)	C_{min}	C_{cr}					
Distancia mínima entre anclajes paralelos a posición horiz (mm) Minimum spacing placed parallel to horizontal joint (mm)	$S_{cr,II}$	500					
Distancia mínima entre anclajes perpendiculares a posición horiz (mm) Minimum spacing placed perpendicular to horizontal joint (mm)	$S_{cr,T}$	314					
Distancia mínima entre anclajes(mm) Minimal Axial distance (mm)	S_{min}	S_{cr}					
Carga de tracción recomendada (kg) Recommended Tension Load (kg)	N_{Rec}	11	14			17	
Carga Vertical de cizalladura recomendada (kg) Recommended Vertical Shear Load (kg)	$V_{Rec,v}$	57					
Carga Horizontal de cizalladura recomendada (kg) Recommended Horizontal Shear Load (kg)	$V_{Rec,H}$	36					

Hollow Clay Brick Calibric R+		Dimensions 500x200x314	Compressive Strength $\geq 6 \text{ N/mm}^2$			Density $\geq 0,6 \text{ kg/dm}^3$	
			M8	M8	M10	M12	M16
Con Tamiz – With sleeve			12	16	16	20	20
Profundidad efectiva (mm) Effective anchorage depth(mm)	h_{ef}	80	85 ; 130				
Espesor mínimo pared (mm) Minimum wall thickness (mm)	h_{min}	200					
Par de apriete (N·m) Installation torque (N·m)	T_{inst}	2					
Distancia crítica al borde (mm) Critical edge distance (mm)	C_{cr}	120					
Distancia mínima a borde (mm) Minimal Edge distance (mm)	C_{min}	C_{cr}					
Distancia mínima entre anclajes paralelos a posición horiz (mm) Minimum spacing placed parallel to horizontal joint (mm)	$S_{cr,II}$	500					
Distancia mínima entre anclajes perpendiculares a posición horiz (mm) Minimum spacing placed perpendicular to horizontal joint (mm)	$S_{cr,T}$	314					
Distancia mínima entre anclajes(mm) Minimal Axial distance (mm)	S_{min}	S_{cr}					
Carga de tracción recomendada (kg) Recommended Tension Load (kg)	N_{Rec}	21					
Carga Vertical de cizalladura recomendada (kg) Recommended Vertical Shear Load (kg)	$V_{Rec,V}$	71	100	100	171	171	
Carga Horizontal de cizalladura recomendada (kg) Recommended Horizontal Shear Load (kg)	$V_{Rec,H}$	36					

Hollow Clay Brick URBANBRIC		Dimensions 560x200x274	Compressive Strength ≥ 9 N/mm²					Density ≥ 0,7 kg/dm³
			M8	M8	M10	M12	M16	
Con Tamiz – With sleeve			12	16	16	20	20	
Profundidad efectiva (mm) Effective anchorage depth(mm)	h_{ef}	80	85 ; 130					
Espesor mínimo pared (mm) Minimum wall thickness (mm)	h_{min}	200						
Par de apriete (N·m) Installation torque (N·m)	T_{inst}	2						
Distancia crítica al borde (mm) Critical edge distance (mm)	C_{cr}	120						
Distancia mínima a borde (mm) Minimal Edge distance (mm)	C_{min}	C_{cr}						
Distancia mínima entre anclajes paralelos a posición horiz (mm) Minimum spacing placed parallel to horizontal joint (mm)	$S_{cr,II}$	500						
Distancia mínima entre anclajes perpendiculares a posición horiz (mm) Minimum spacing placed perpendicular to horizontal joint (mm)	$S_{cr,T}$	274						
Distancia mínima entre anclajes(mm) Minimal Axial distance (mm)	S_{min}	S_{cr}						
Carga de tracción recomendada (kg) Recommended Tension Load (kg)	N_{Rec}	26	34					
Carga Vertical de cizalladura recomendada (kg) Recommended Vertical Shear Load (kg)	$V_{Rec,V}$	86	100	100	114	114		
Carga Horizontal de cizalladura recomendada (kg) Recommended Horizontal Shear Load (kg)	$V_{Rec,H}$	36						

Hollow Clay Brick POROTHERM HOMEBRIC		Dimensions 500x200x300	Compressive Strength ≥ 6 N/mm²				Density ≥ 0,7 kg/dm³
			M8	M8	M10	M12	
Con Tamiz – With sleeve			12	16	16	20	20
Profundidad efectiva (mm) Effective anchorage depth(mm)	h_{ef}	80	85 ; 130				
Espesor mínimo pared (mm) Minimum wall thickness (mm)	h_{min}	200					
Par de apriete (N·m) Installation torque (N·m)	T_{inst}	2					
Distancia crítica al borde (mm) Critical edge distance (mm)	C_{cr}	120					
Distancia mínima a borde (mm) Minimal Edge distance (mm)	C_{min}	C_{cr}					
Distancia mínima entre anclajes paralelos a posición horiz (mm) Minimum spacing placed parallel to horizontal joint (mm)	$S_{cr,II}$	500					
Distancia mínima entre anclajes perpendiculares a posición horiz (mm) Minimum spacing placed perpendicular to horizontal joint (mm)	$S_{cr,T}$	300					
Distancia mínima entre anclajes(mm) Minimal Axial distance (mm)	S_{min}	S_{cr}					
Carga de tracción recomendada (kg) Recommended Tension Load (kg)	N_{zul}	26	34				
Carga Vertical de cizalladura recomendada (kg) Recommended Vertical Shear Load (kg)	$V_{Rec,V}$	57	57	57	86	86	
Carga Horizontal de cizalladura recomendada (kg) Recommended Horizontal Shear Load (kg)	$V_{Rec,H}$	36					

Hollow Clay Brick BLOCCHI LEGGERI		Dimensions 250x120x250	Compressive Strength ≥ 8 N/mm²					Density ≥ 0,6 kg/dm³
			M8	M8	M10	M12	M16	
Con Tamiz – With sleeve			12	16	16	20	20	
Profundidad efectiva (mm) Effective anchorage depth(mm)	h_{ef}	80	85 ; 130 ; 200					
Espesor mínimo pared (mm) Minimum wall thickness (mm)	h_{min}	$H_{ef} + 30$ mm						
Par de apriete (N·m) Installation torque (N·m)	T_{inst}	2						
Distancia crítica al borde (mm) Critical edge distance (mm)	C_{cr}	120						
Distancia mínima a borde (mm) Minimal Edge distance (mm)	C_{min}	C_{cr}						
Distancia mínima entre anclajes paralelos a posición horis (mm) Minimum spacing placed parallel to horizontal joint (mm)	$S_{cr,II}$	250						
Distancia mínima entre anclajes perpendiculares a posición horis (mm) Minimum spacing placed perpendicular to horizontal joint (mm)	$S_{cr,T}$	120						
Distancia mínima entre anclajes(mm) Minimal Axial distance (mm)	S_{min}	S_{cr}						
Carga de tracción recomendada (kg) Recommended Tension Load (kg)	N_{Rec}	17						
Carga Vertical de cizalladura recomendada (kg) Recommended Vertical Shear Load (kg)	$V_{Rec,V}$	57						
Carga Horizontal de cizalladura recomendada (kg) Recommended Horizontal Shear Load (kg)	$V_{Rec,H}$	43						

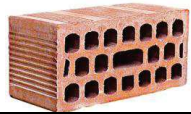
Hollow Clay Brick DOPPIO UNI		Dimensions 250x120x120	Compressive Strength ≥ 20 N/mm²					Density ≥ 0,9 kg/dm³
			M 8	M8	M10	M12	M16	
Con Tamiz – With sleeve			12	16	16	20	20	
Profundidad efectiva (mm) Effective anchorage depth(mm)	h_{ef}	80	85 ; 130 ; 200					
Espesor mínimo pared (mm) Minimum wall thickness (mm)	h_{min}	$H_{ef} + 30 \text{ mm}$						
Par de apriete (N·m) Installation torque (N·m)	T_{inst}	2						
Distancia crítica al borde (mm) Critical edge distance (mm)	C_{cr}	120						
Distancia mínima a borde (mm) Minimal Edge distance (mm)	C_{min}	C_{cr}						
Distancia mínima entre anclajes paralelos a posición horiz (mm) Minimum spacing placed parallel to horizontal joint (mm)	$S_{cr,II}$	250						
Distancia mínima entre anclajes perpendiculares a posición horiz (mm) Minimum spacing placed perpendicular to horizontal joint (mm)	$S_{cr,T}$	120						
Distancia mínima entre anclajes(mm) Minimal Axial distance (mm)	S_{min}	S_{cr}						
Carga de tracción recomendada (kg) Recommended Tension Load (kg)	N_{Rec}	26						
Carga Vertical de cizalladura recomendada (kg) Recommended Vertical Shear Load (kg)	$V_{Rec,V}$	57						
Carga Horizontal de cizalladura recomendada (kg) Recommended Horizontal Shear Load (kg)	$V_{Rec,H}$	34						